

1

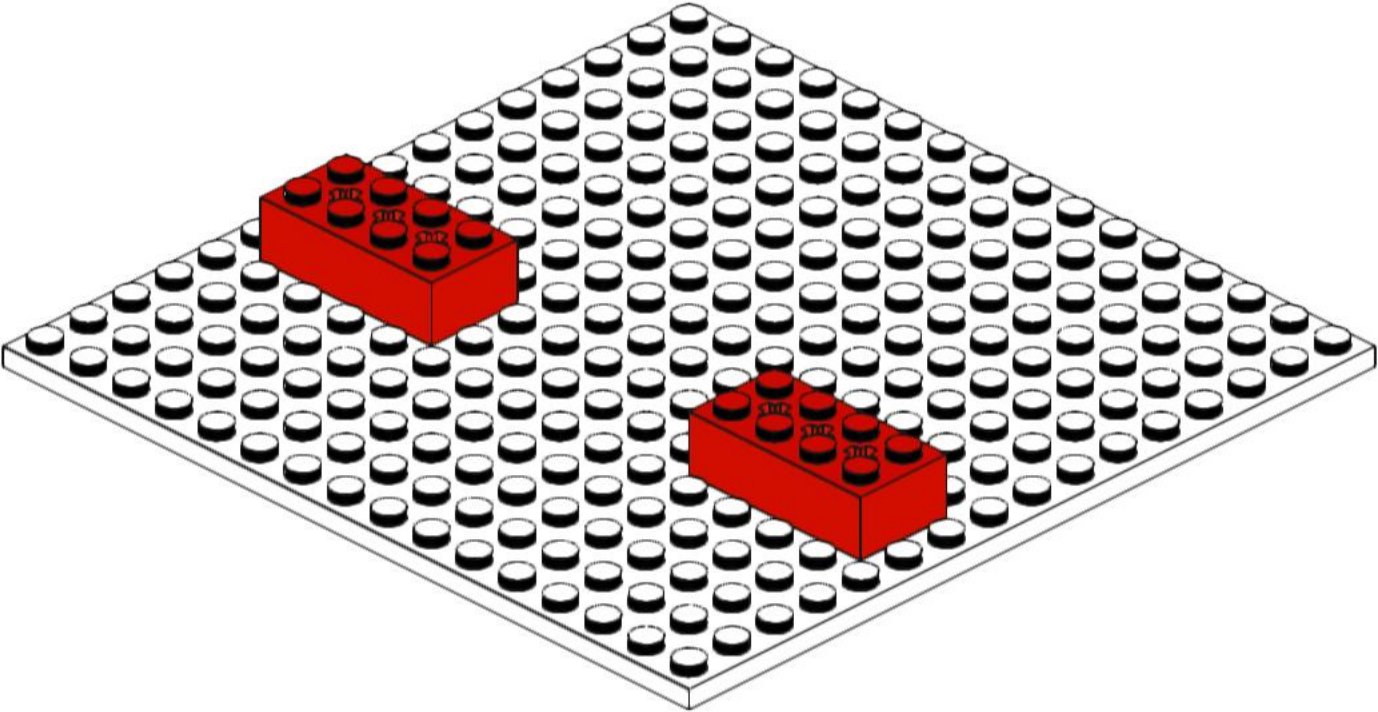

2

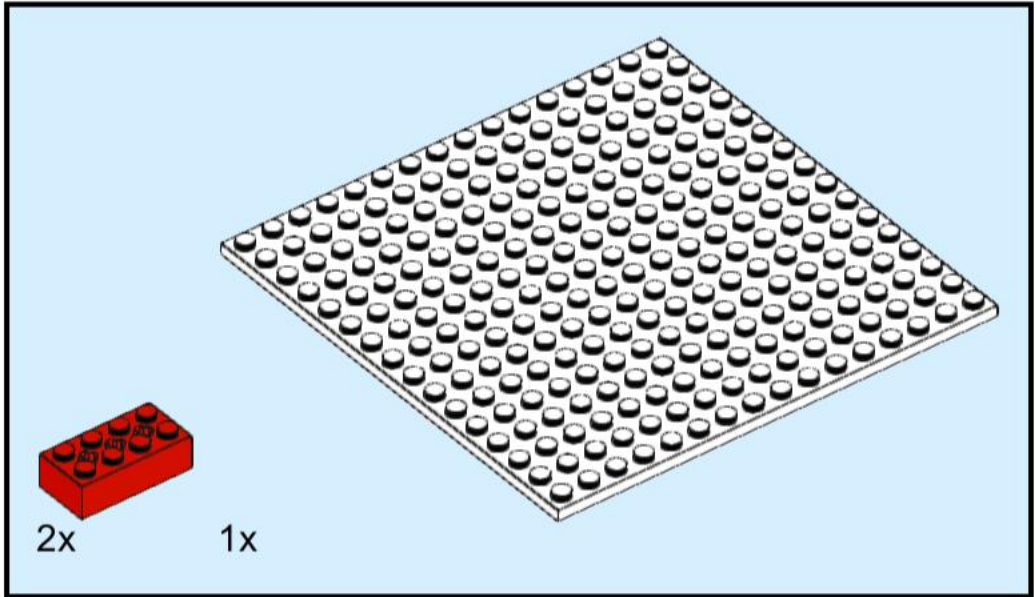
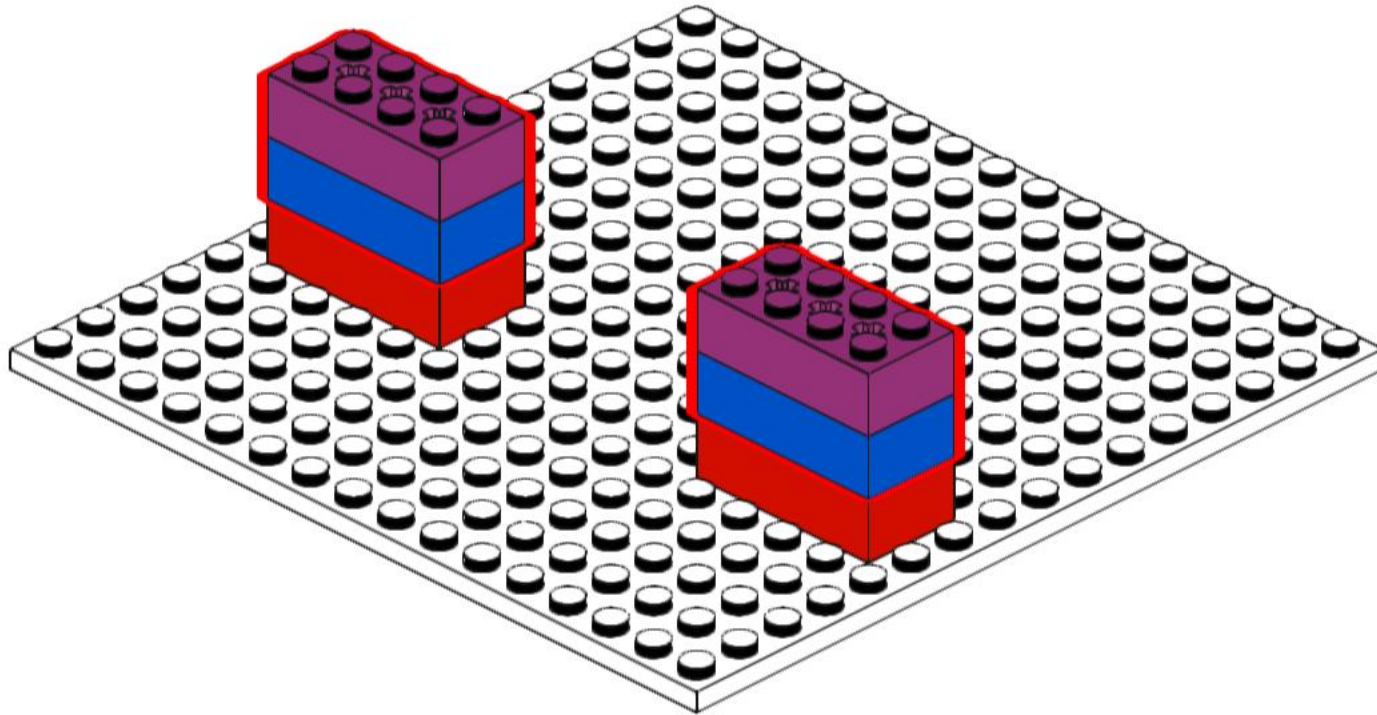
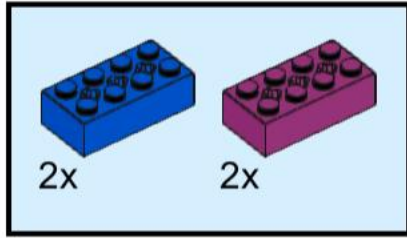

3

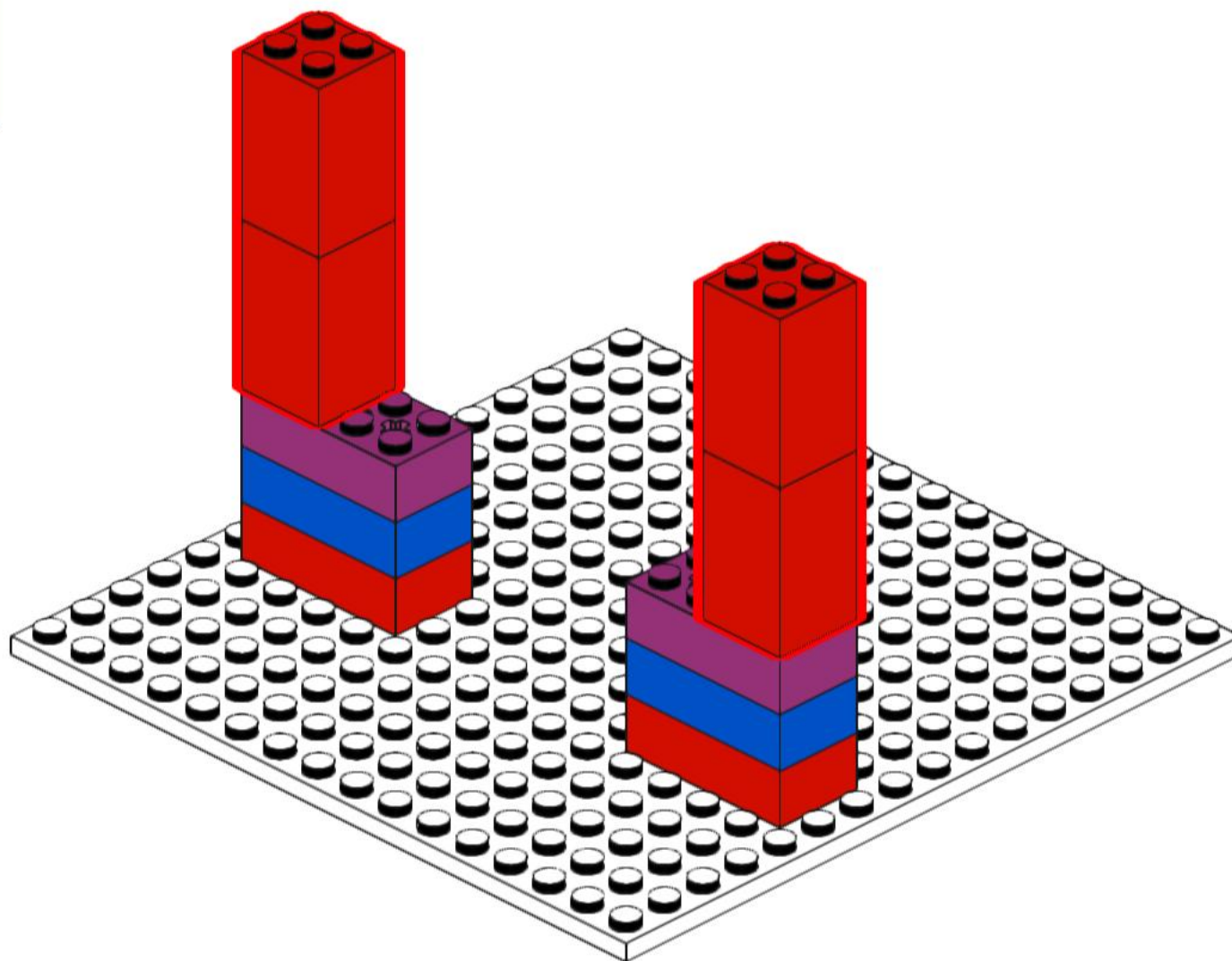
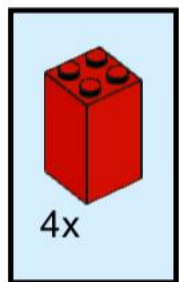

4

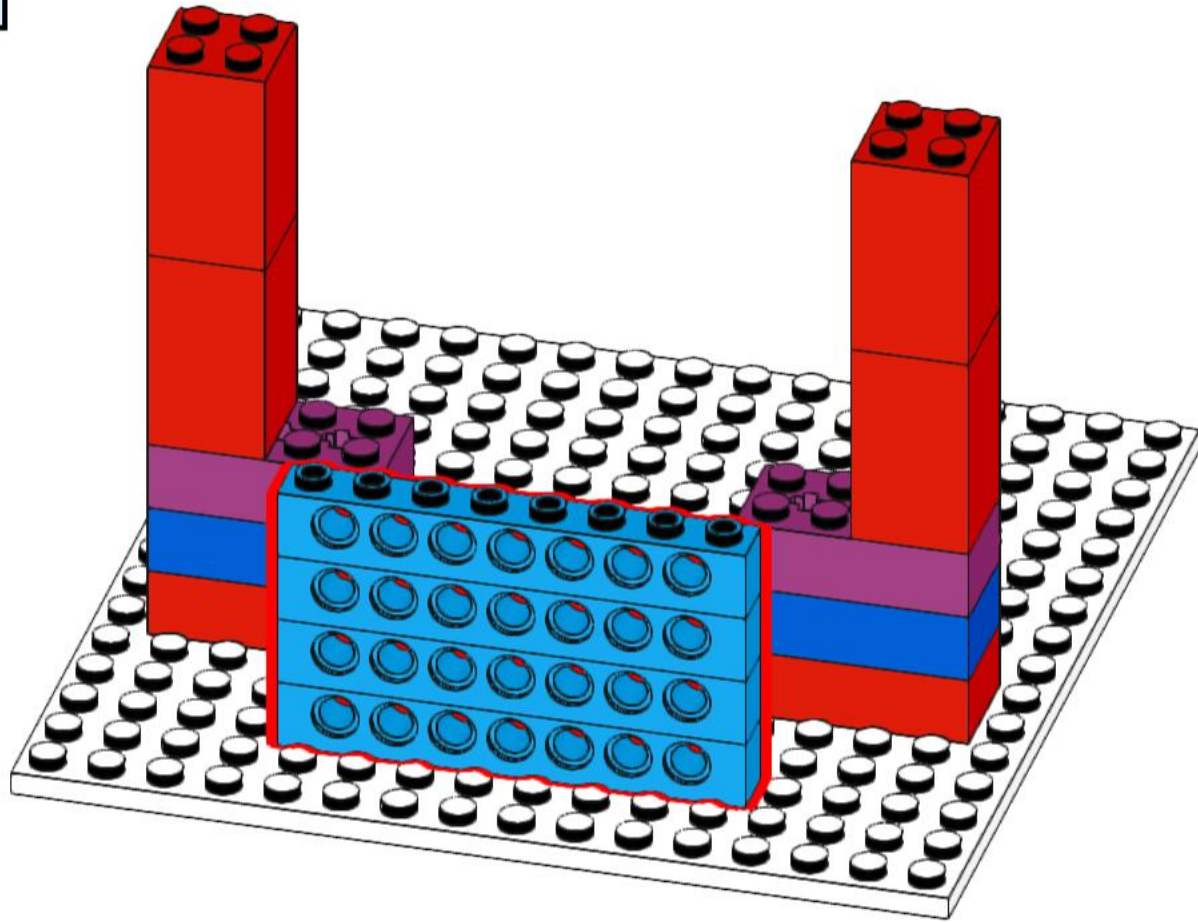
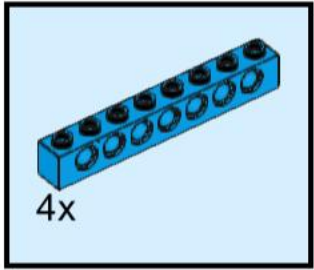

5

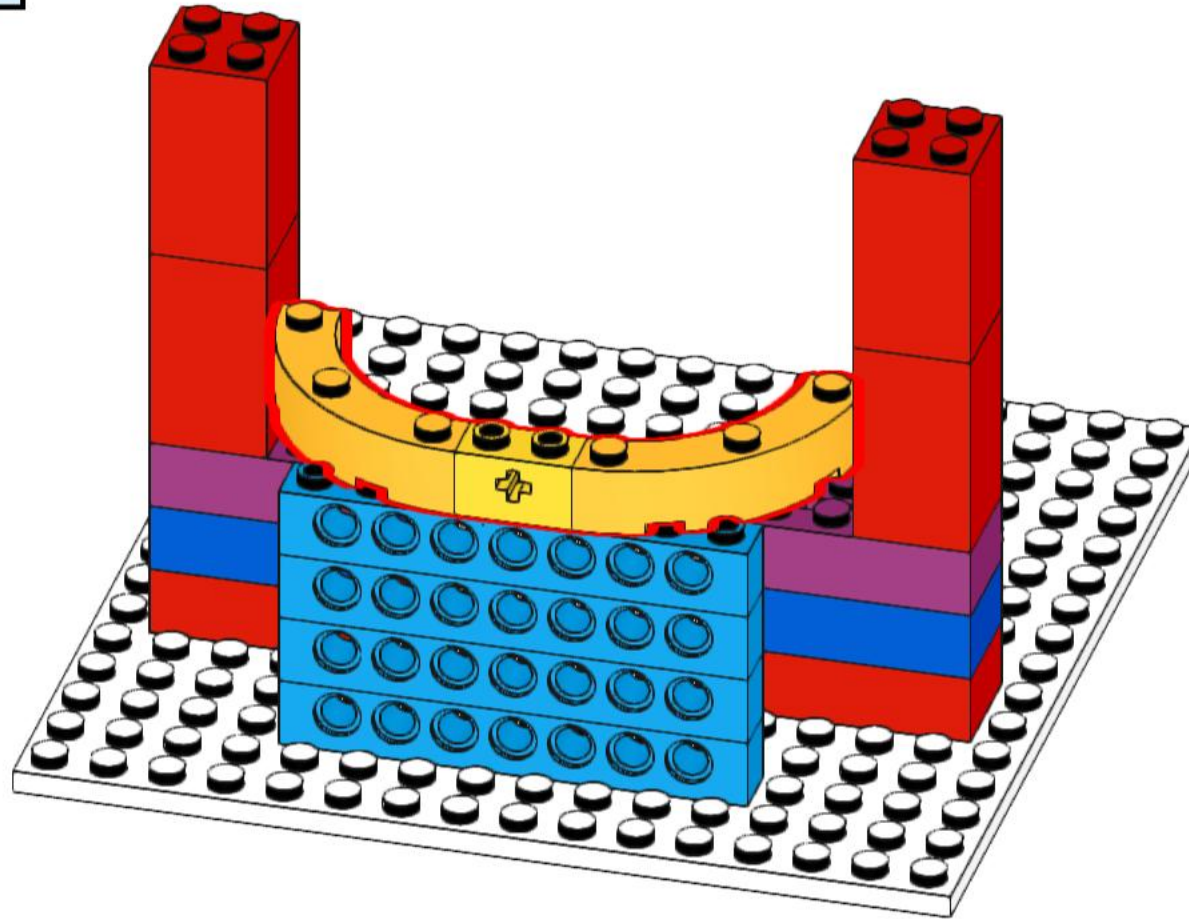
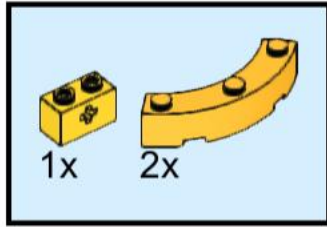

6

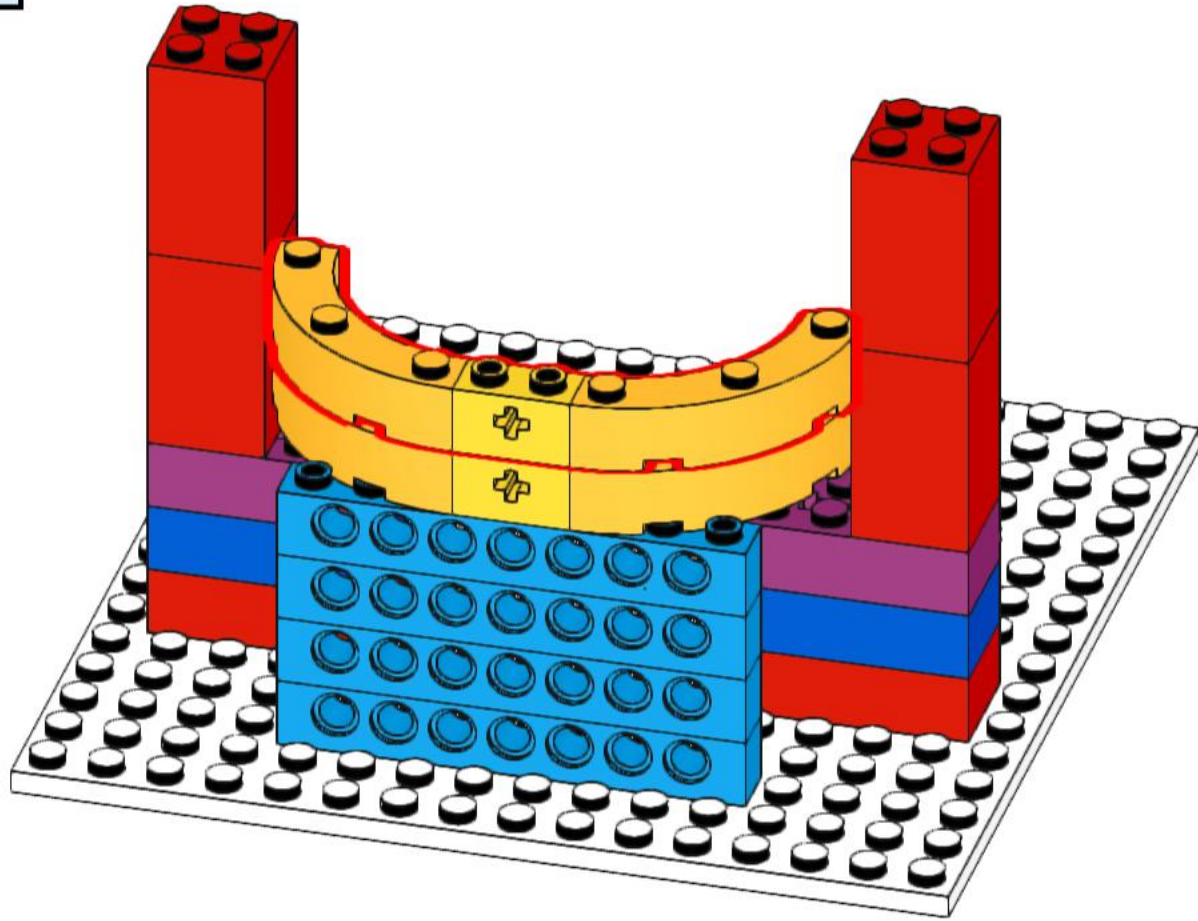
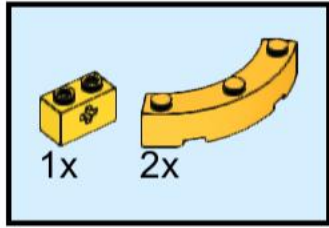

7

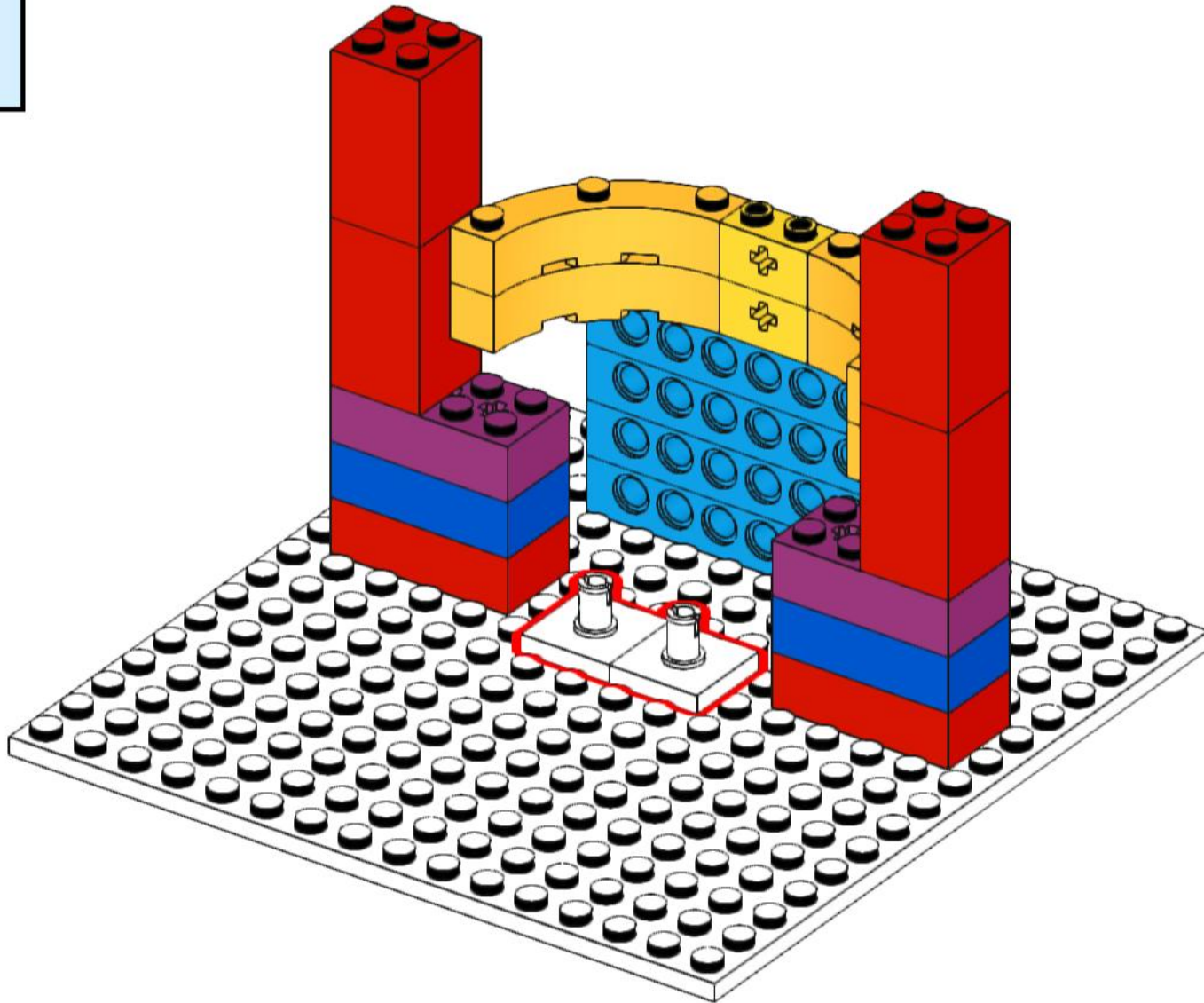
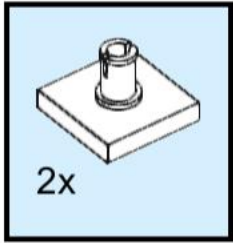

8

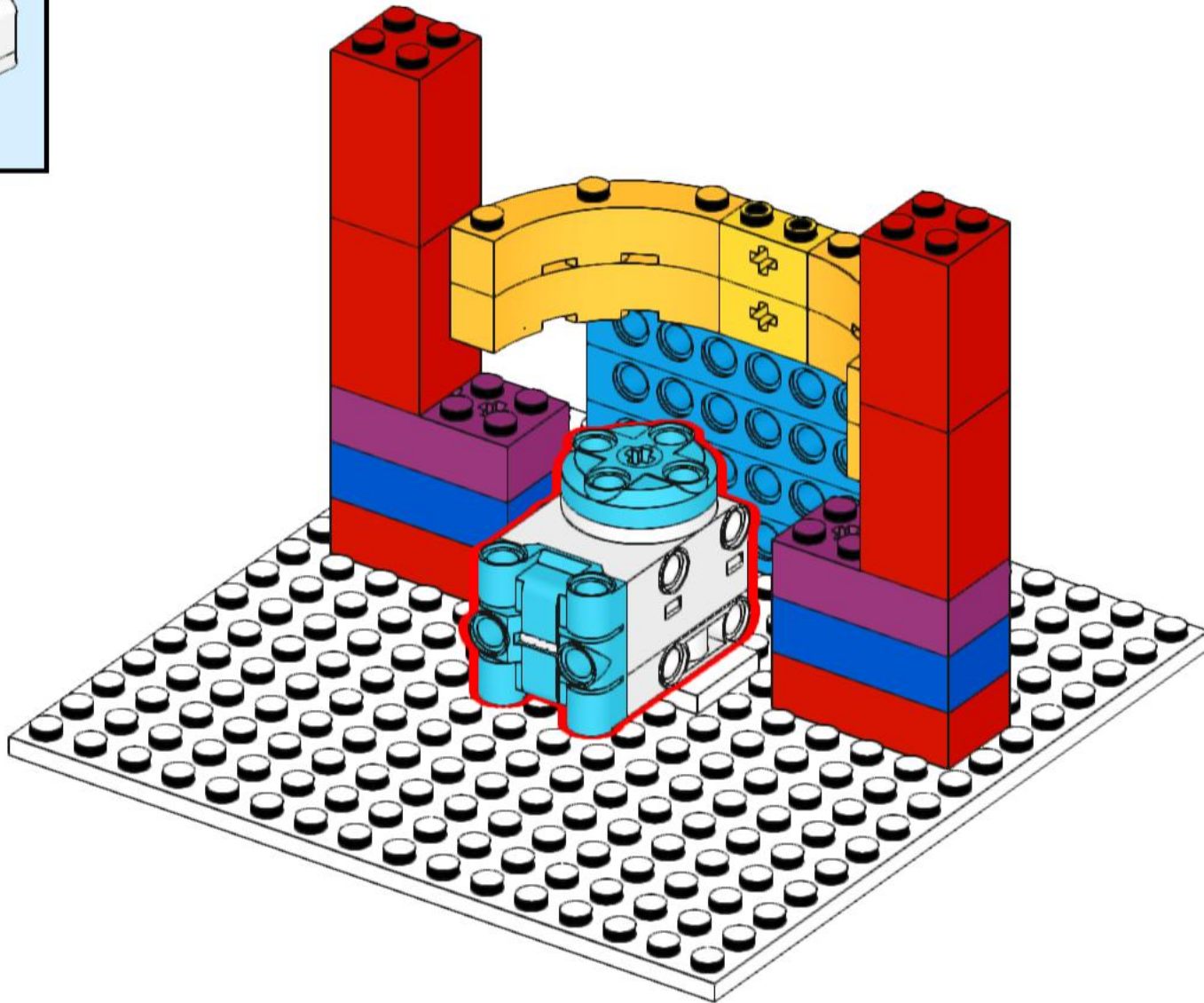
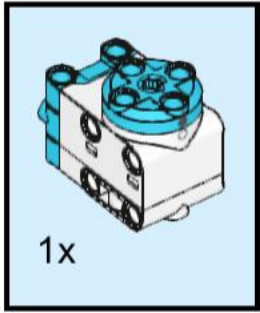

9

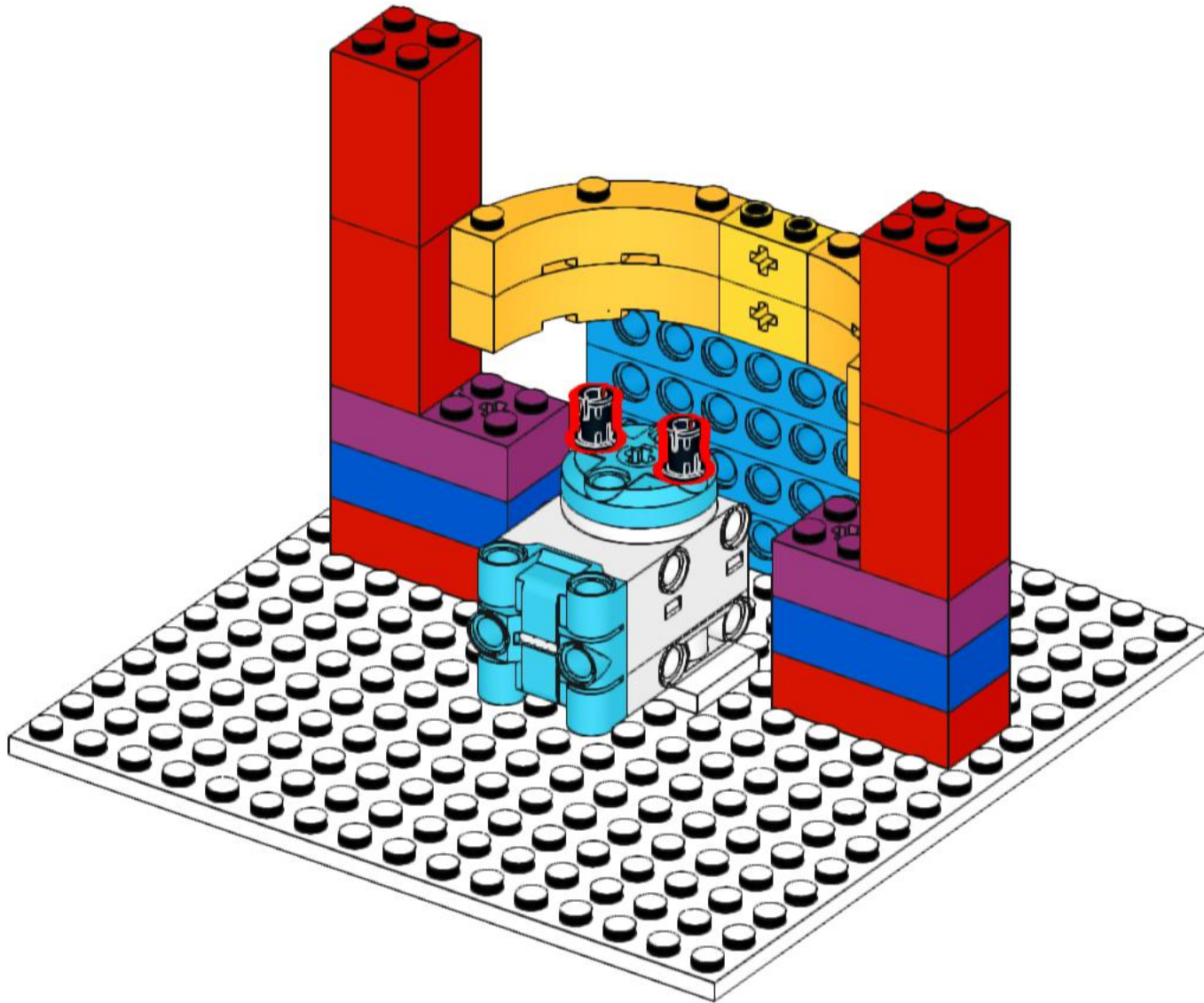

10

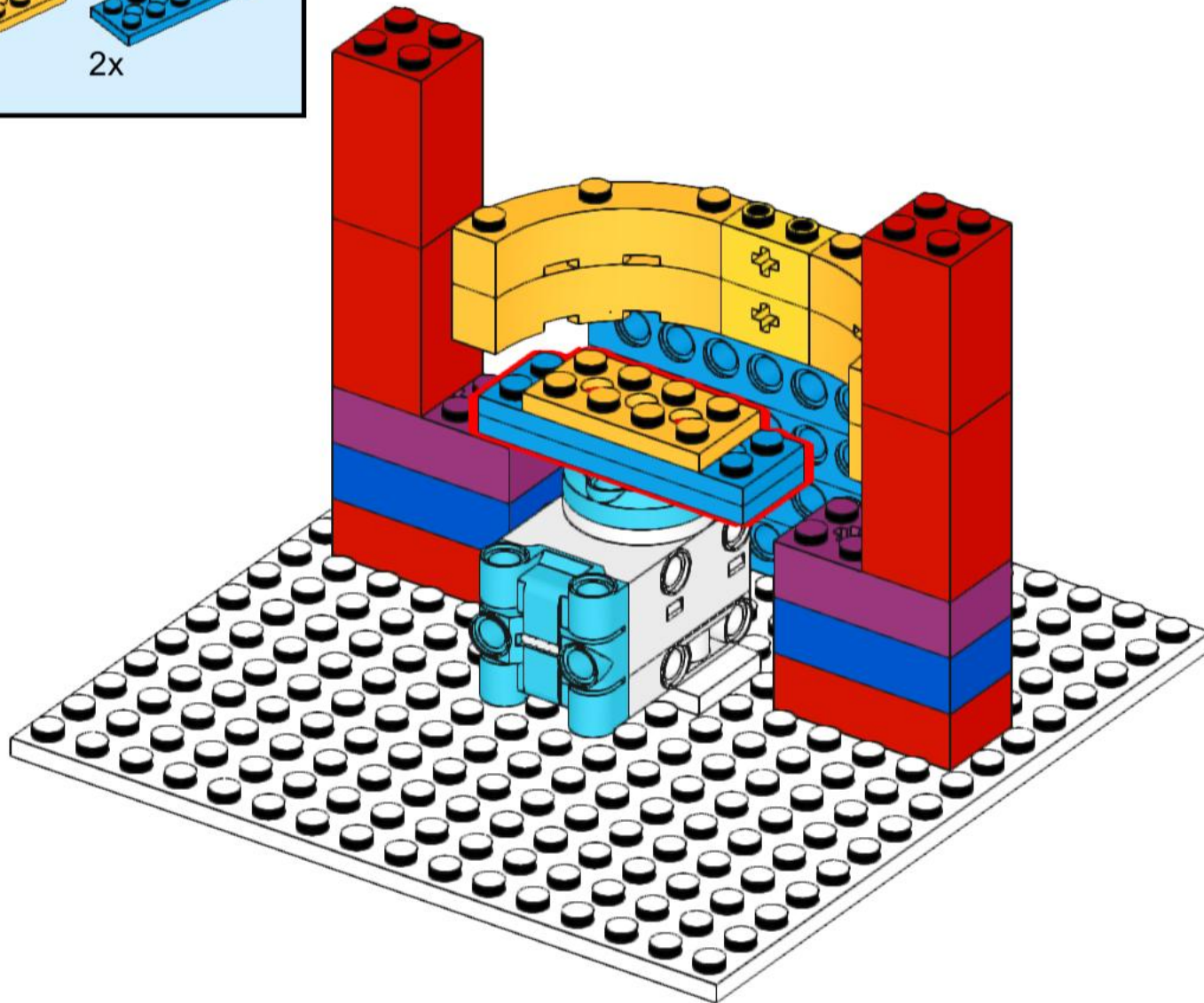
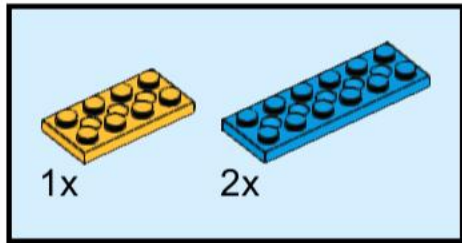

11

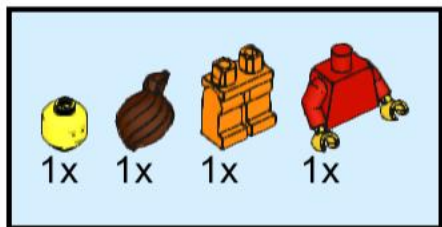

12

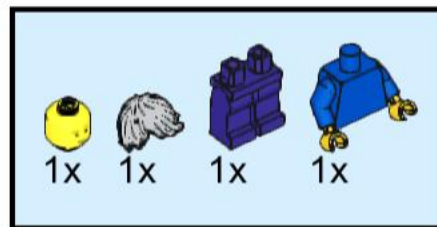

13

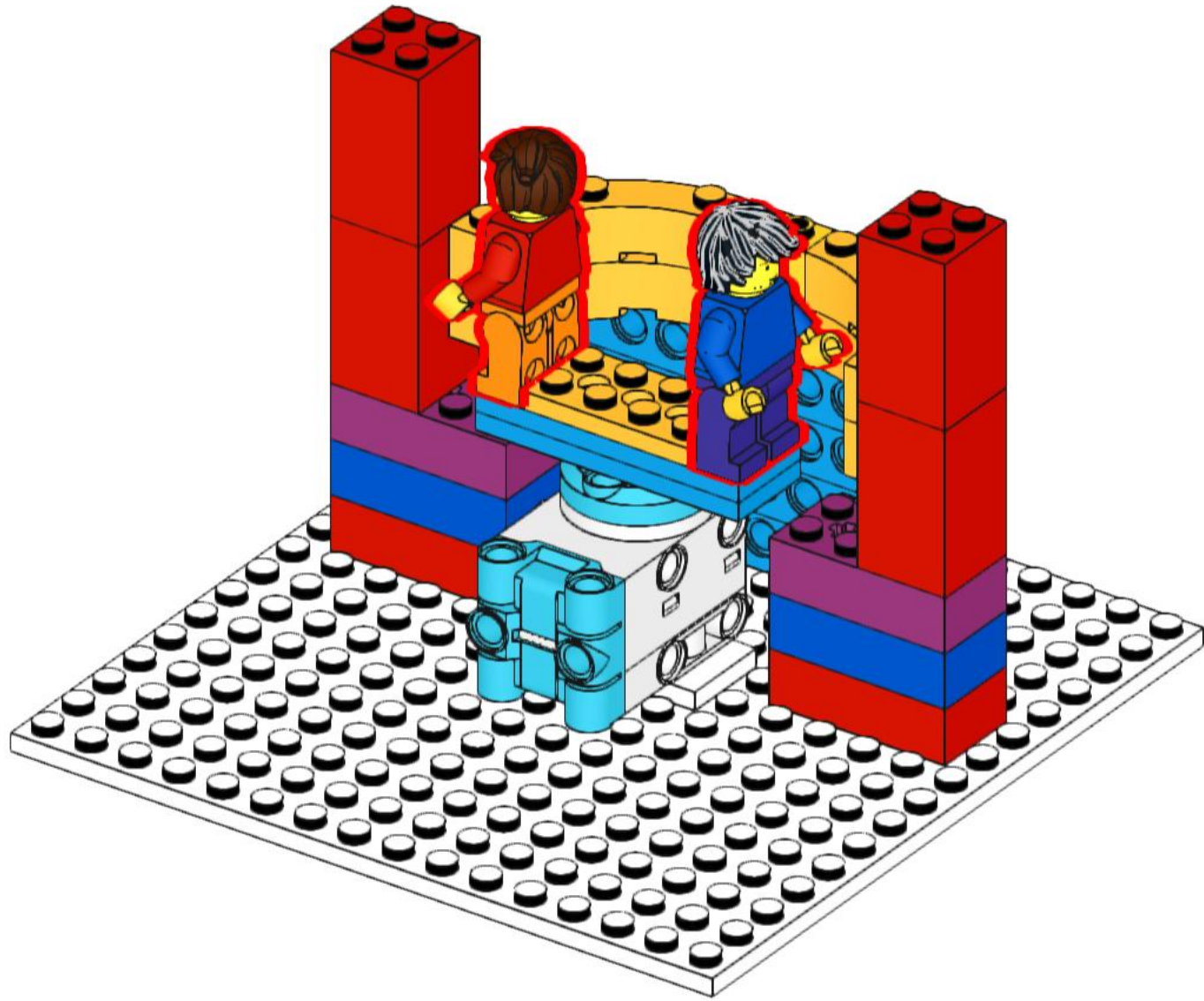

14

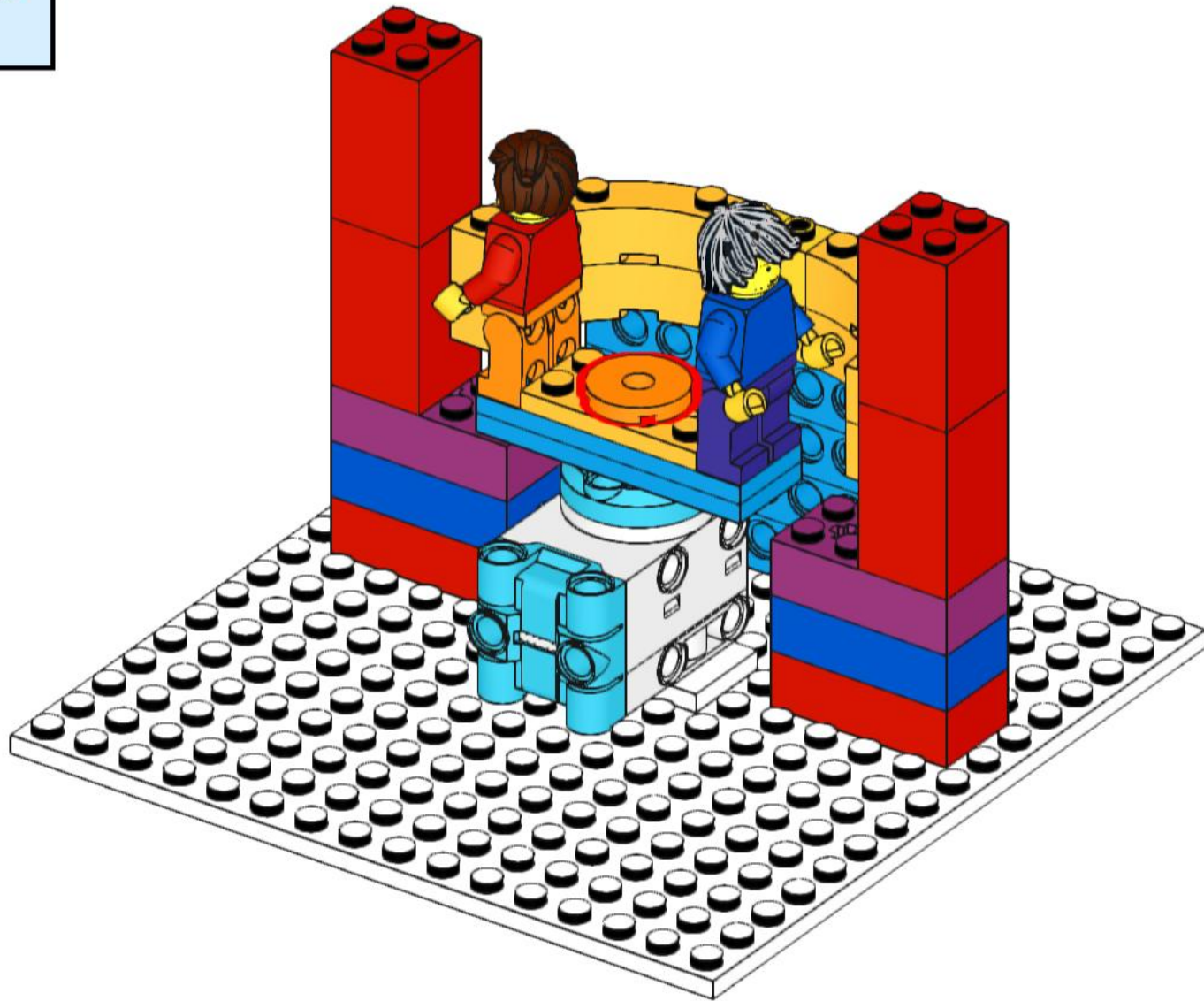
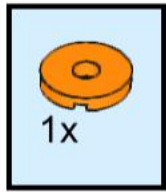

15

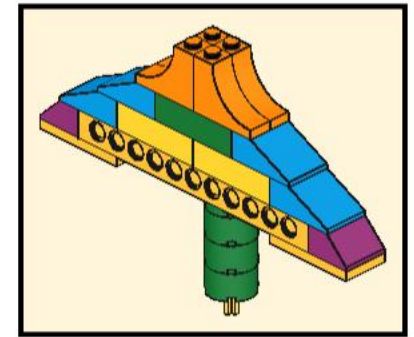
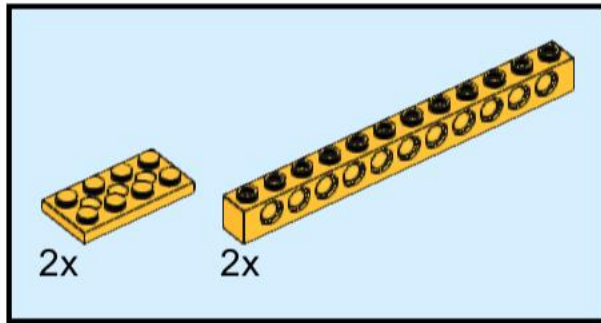

dak

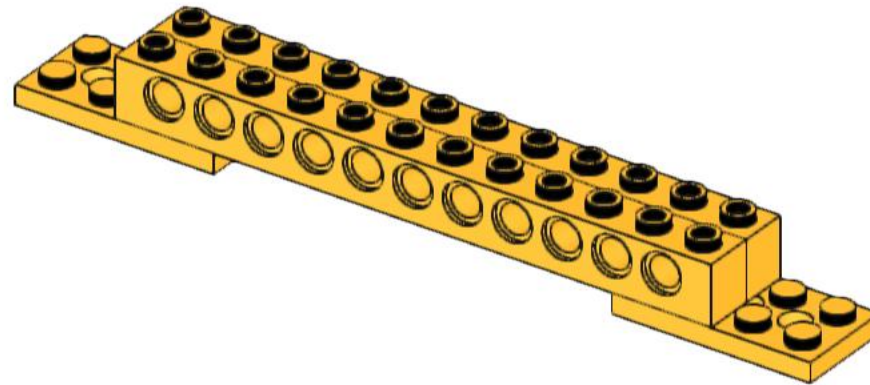

16

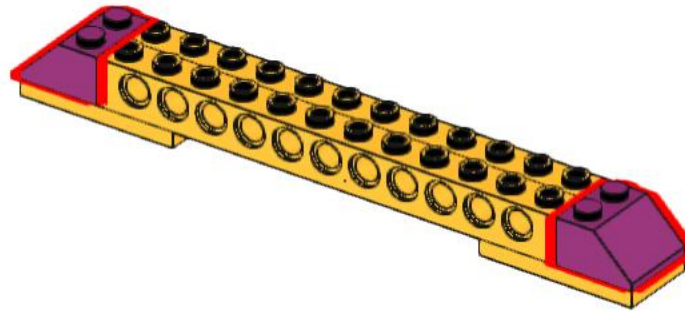
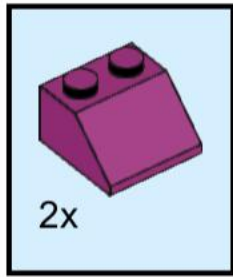

17

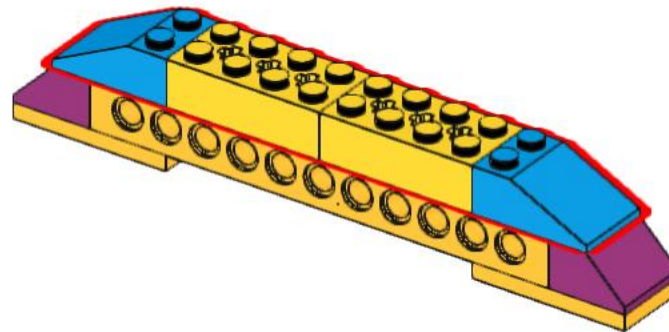
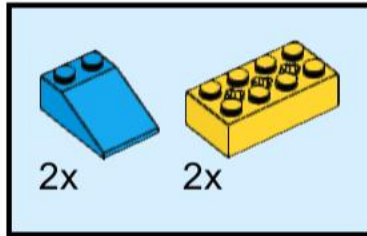

18

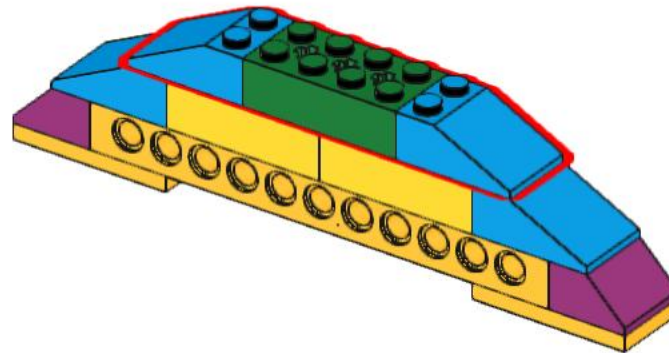
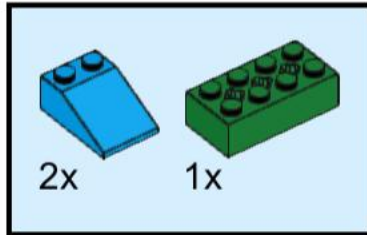

19

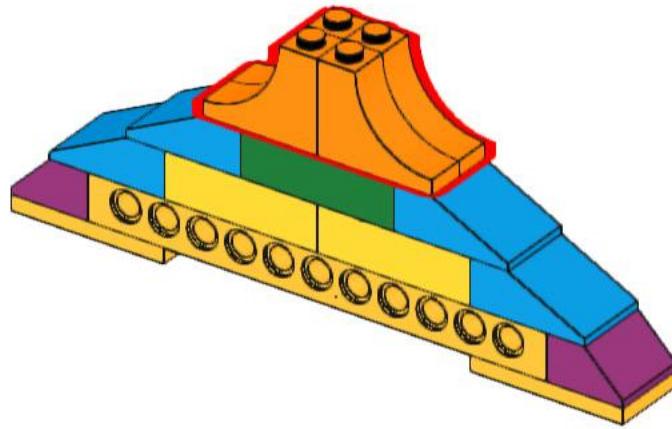
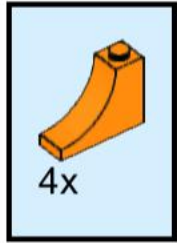

20

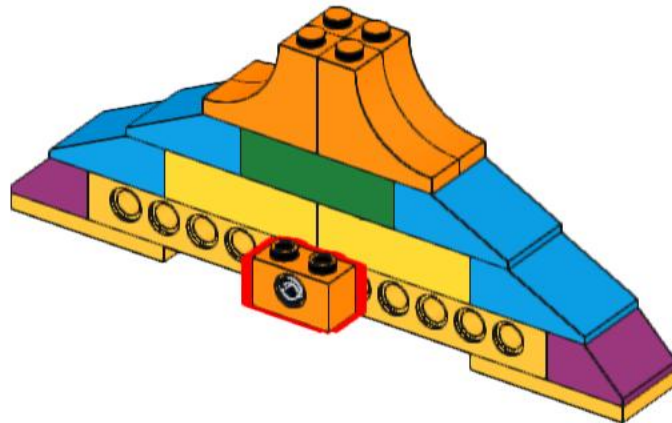
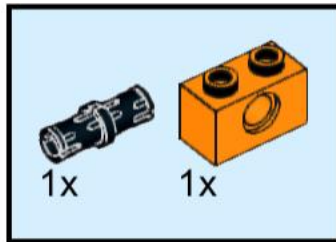

21

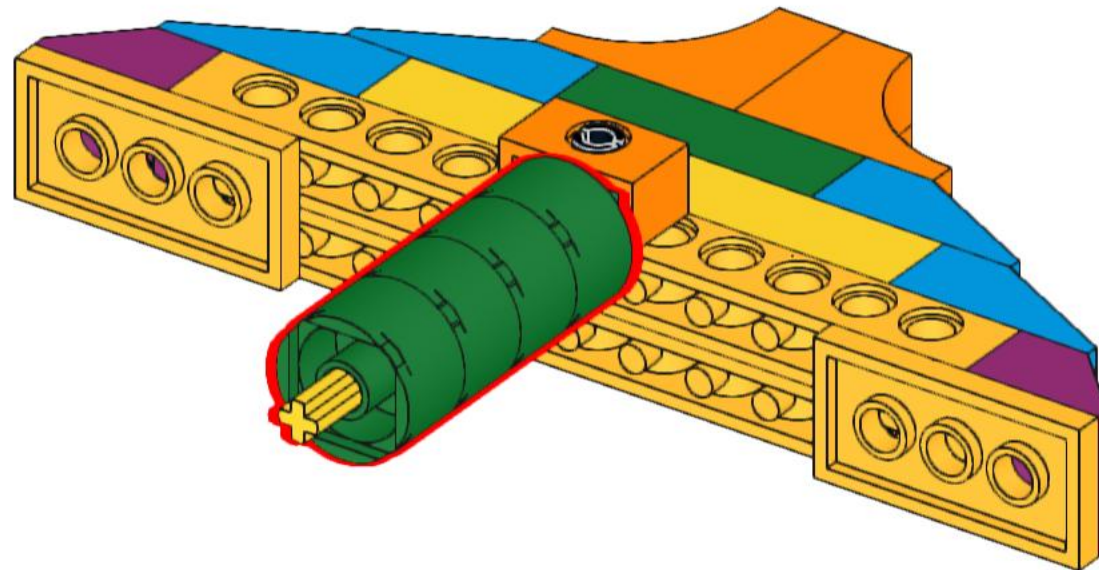
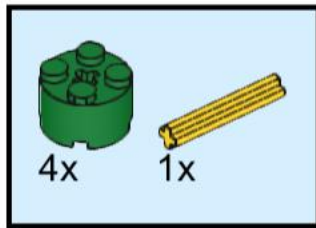

22

Zet het dak op de palen.
Het gele pinnetje past in het
oranje rondje.

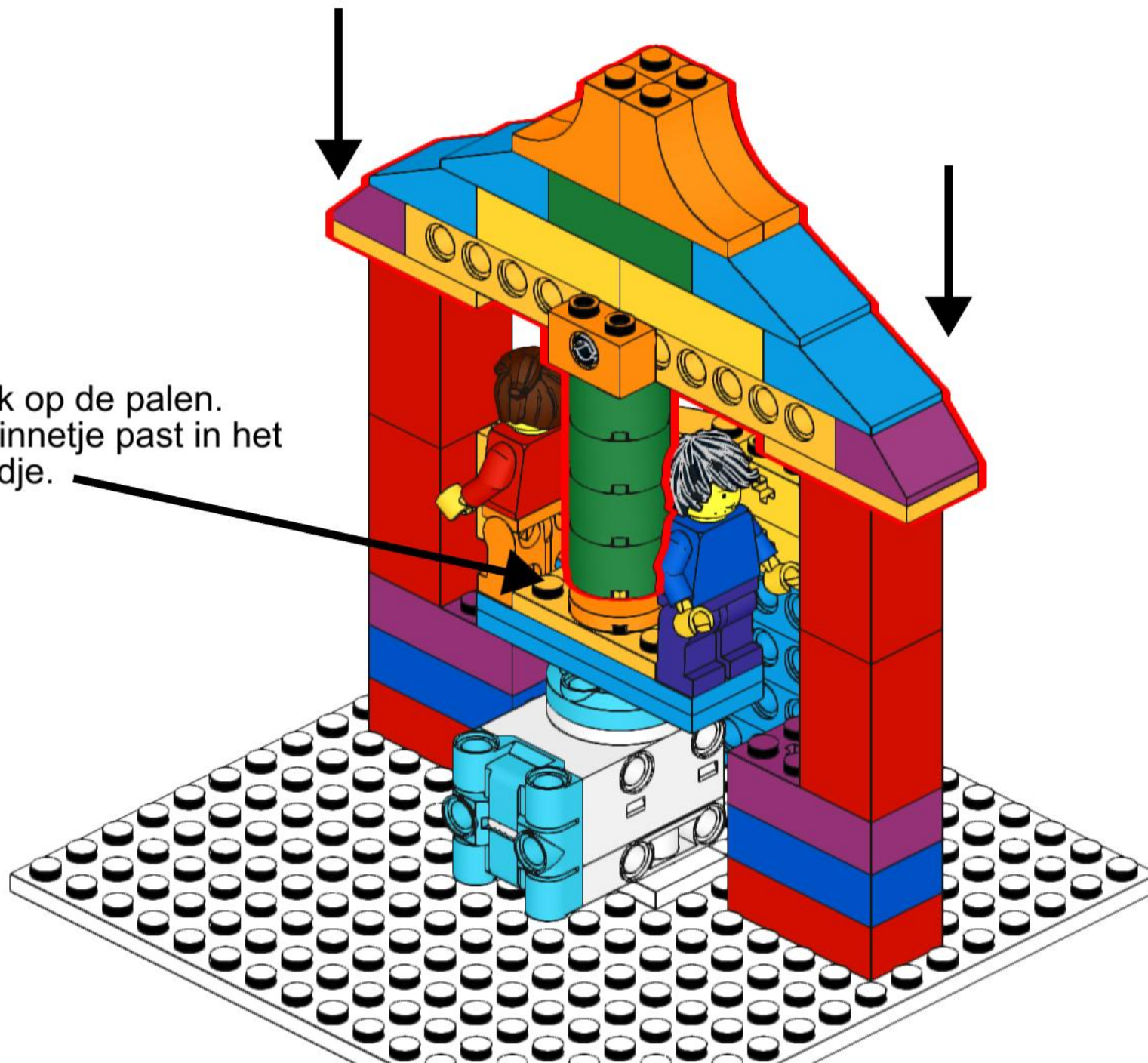

23

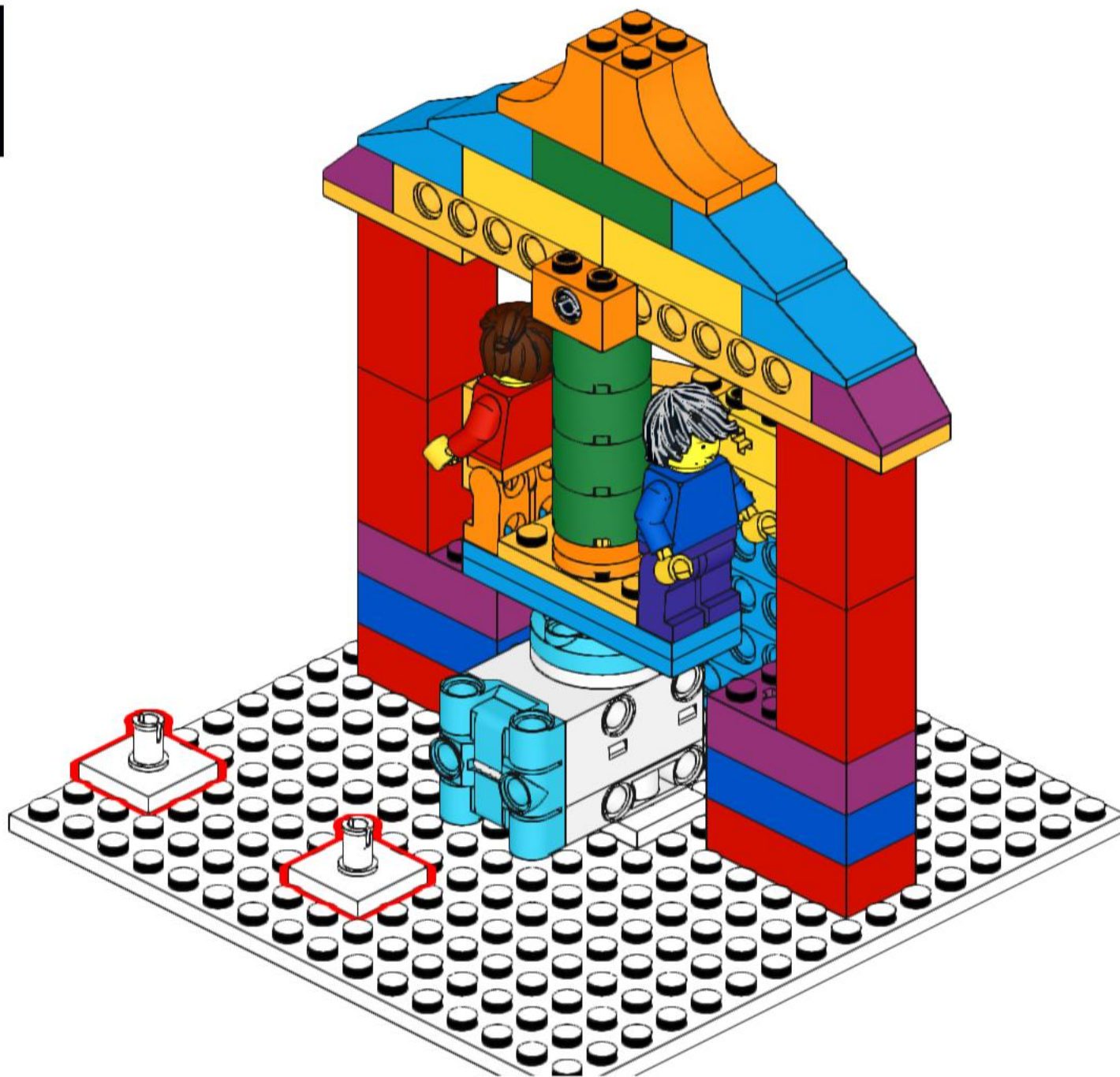
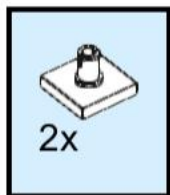

24

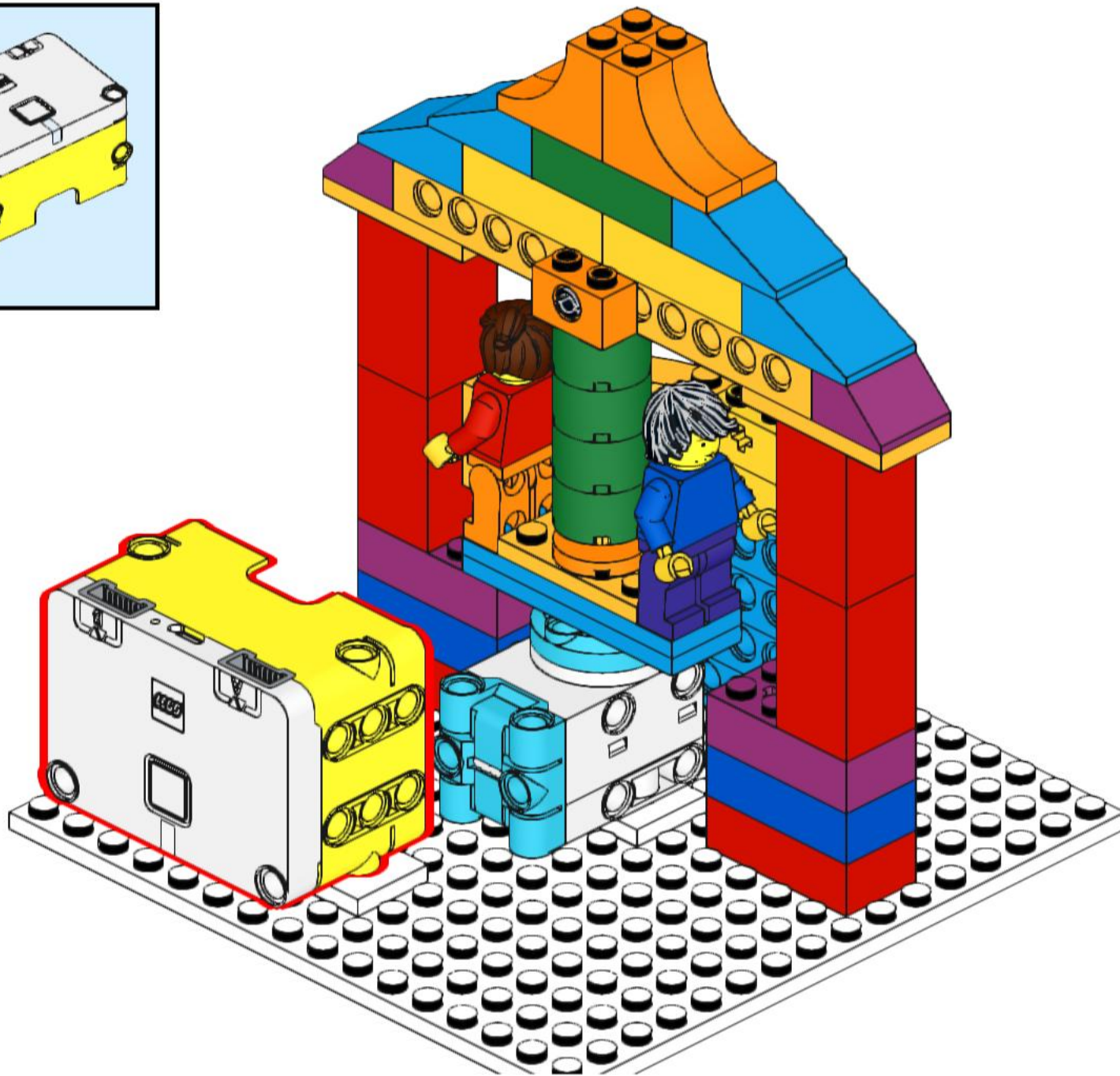
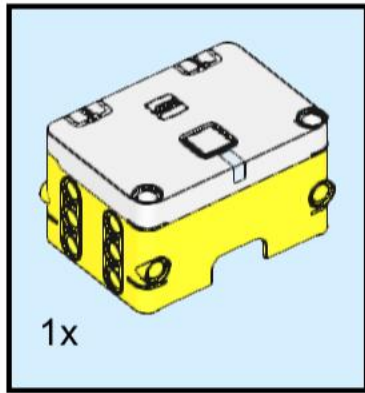

25

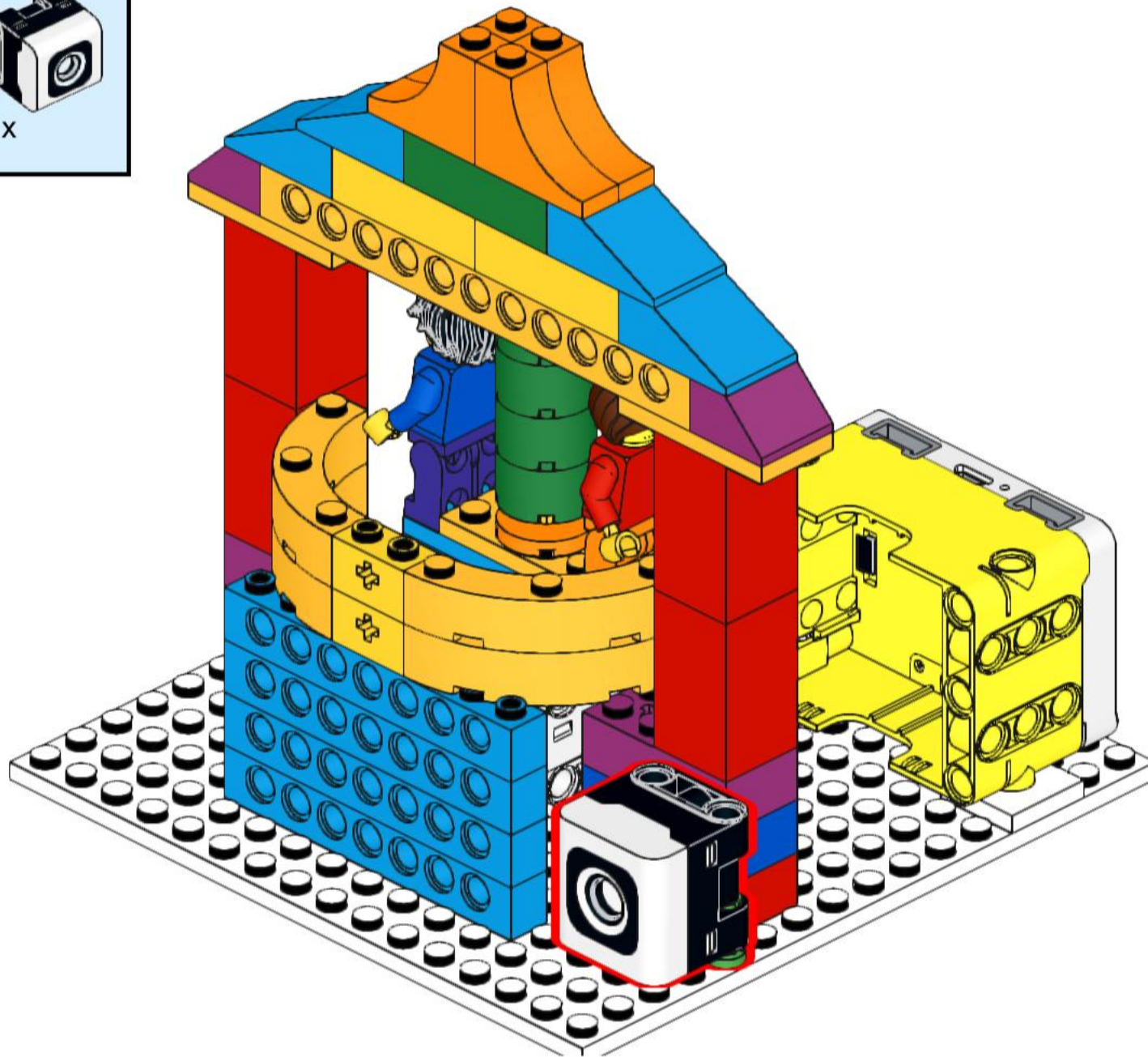
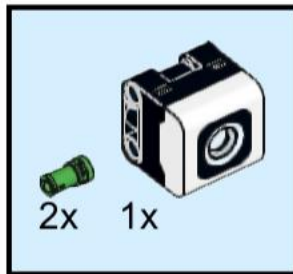

26

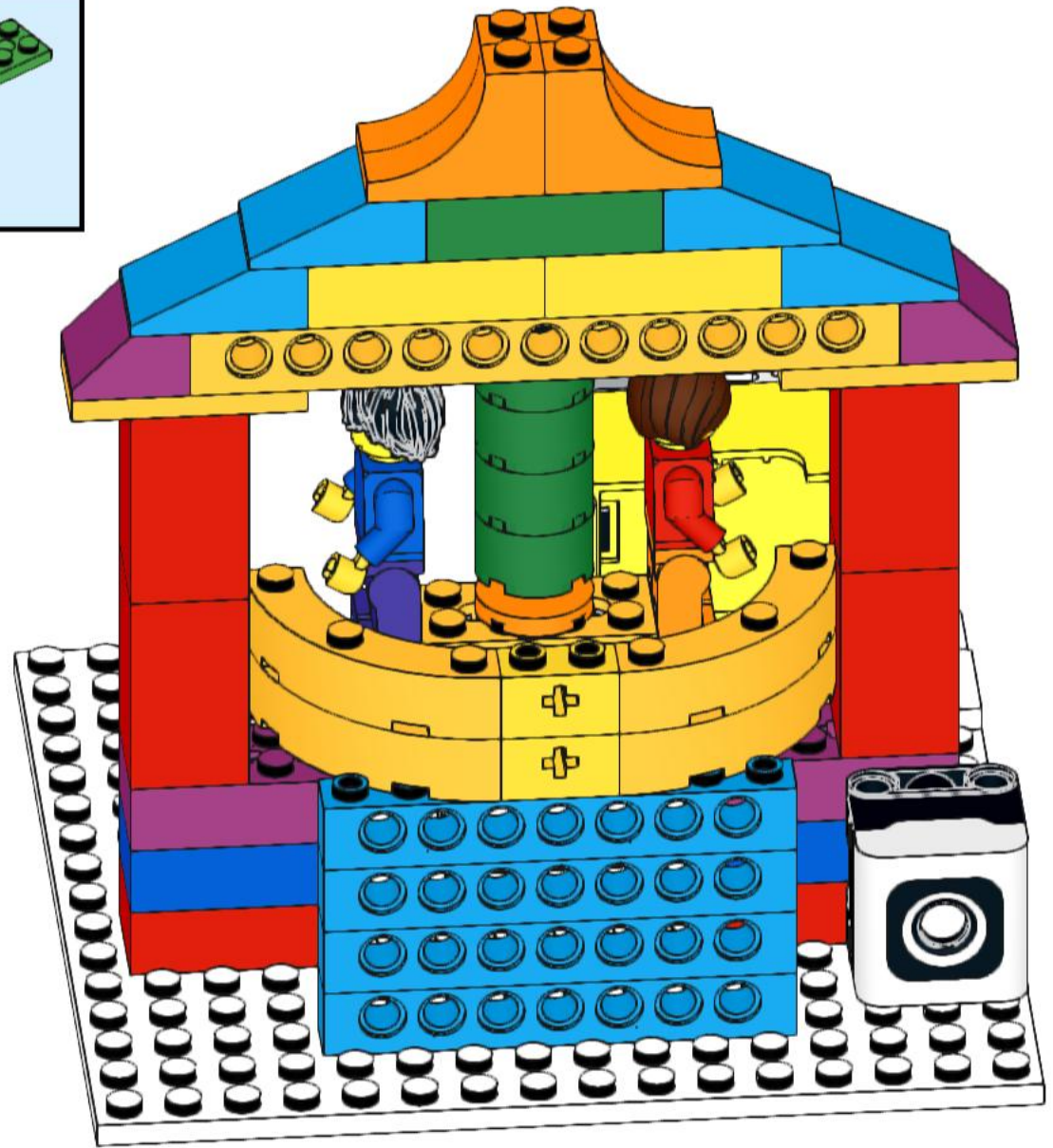
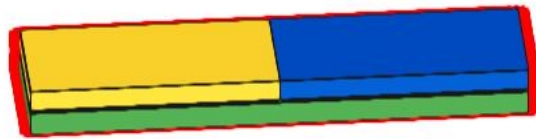
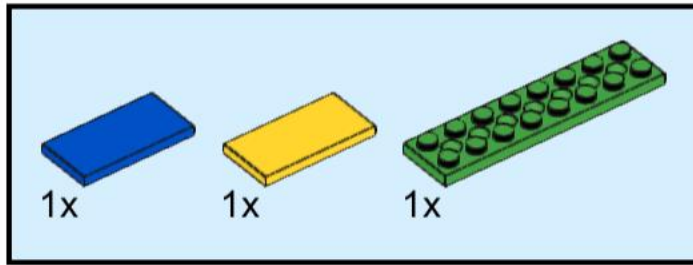

27

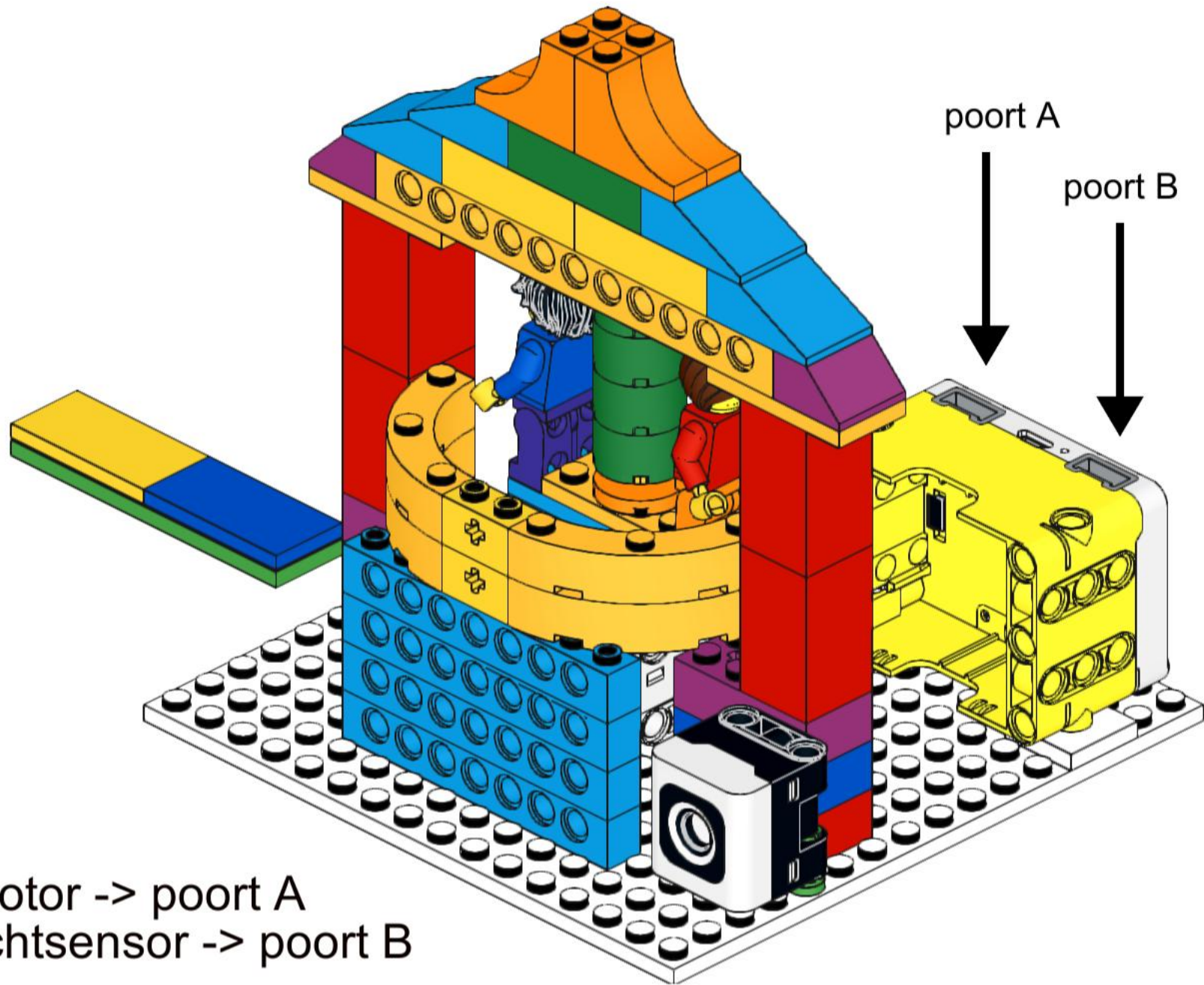

Klaar!
Kabel motor -> poort A
Kabel lichtsensor -> poort B